

Overview

Specially designed storage racks, three tier shelving available in three lengths, The perfect safe and dry storage solution for fresh produce, fruit or vegetables. A heavy duty square section stainless steel framework supports the all stainless steel shelving unit. With adjustable height feet for uneven surfaces. Complete with removable perforated shelf bases and pull out spillage trays.



VEG2

Features:

- Open plan storage on three levels.
- Pull out spillage drawers.
- Removable perforated shelf base trays.
- Adjustable for height floor fixing feet.
- All stainless steel construction.



VEG1 showing pull out spillage trays



VEG3



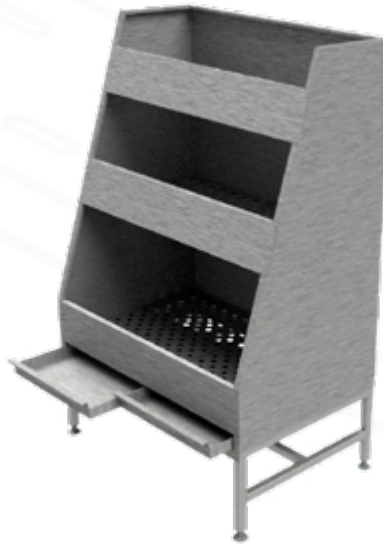
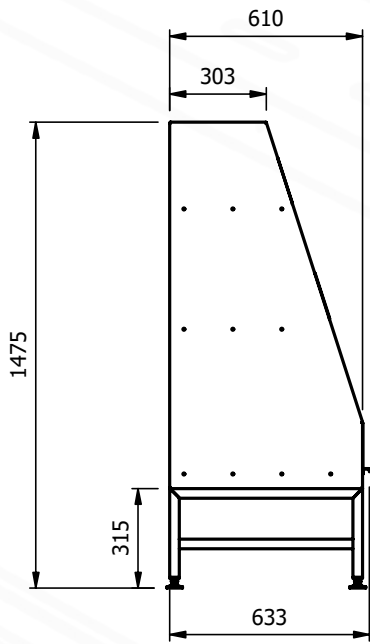

Model	Weight (kg)	L x D x H (mm)
VEG1	37	465 x 633 x 1475
VEG2	72	930 x 633 x 1475
VEG3	109	1395 x 633 x 1475

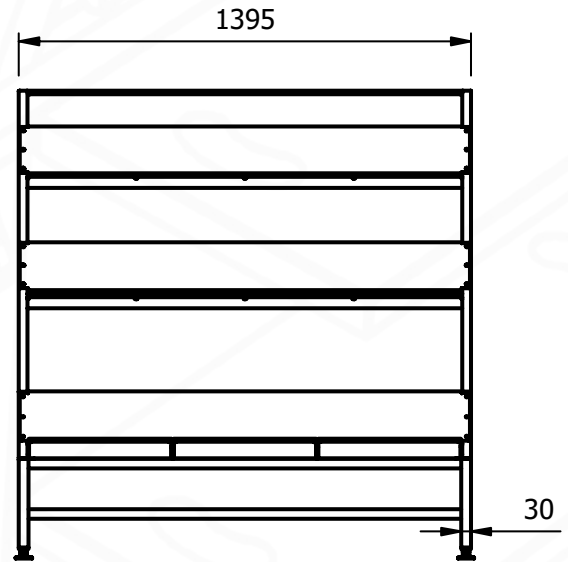
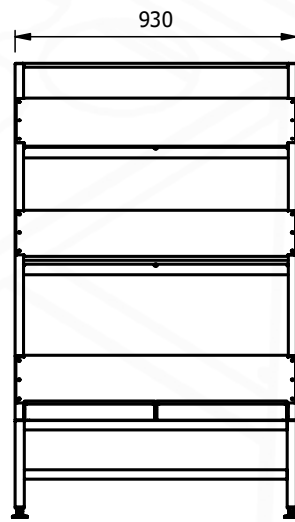
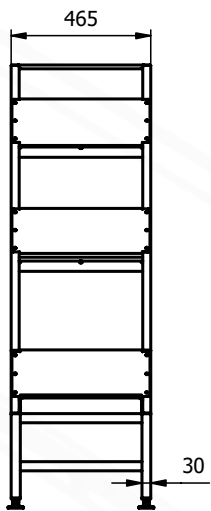
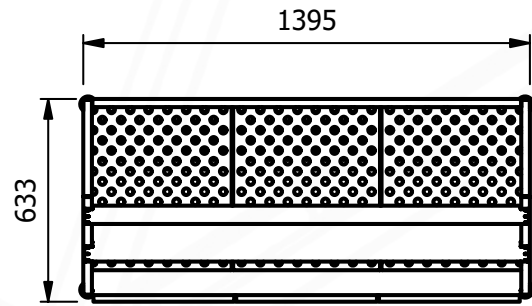
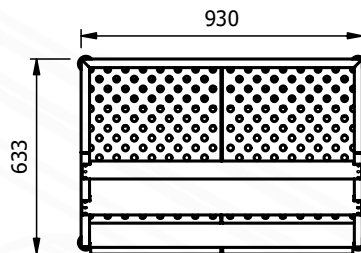
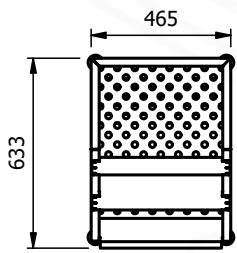

VEG1

VEG2

VEG3

